

WEB-IO-34 Input/Output Module

INSTALLATION INSTRUCTIONS

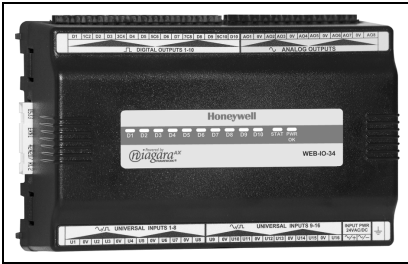

GENERAL

This document covers the mounting, wiring, and initial start-up of WEB-IO-34 expansion module. It assumes that you are an engineer, technician, or service person who is performing control system installation using the Niagara Framework®. Please read this entire document before beginning the installation procedures.

This document does not discuss software installation or station configuration. For more information on these topics, refer to the documents listed in the RELATED DOCUMENTATION section.

PRODUCT DESCRIPTION

The Honeywell WEB-IO-34 is a compact direct WEB-IO module for auxiliary monitoring and control when used with a WEB-201 series controller or other controller platforms as identified in their respective data sheets. This option expands the controller an additional 34 logic-controlled points. Included are 16 universal inputs, 10 form "A" (SPST) relay outputs and 8 analog (voltage only) outputs. This greatly expands the controller monitoring and control capabilities with fast, reliable, direct inputs and outputs for monitoring power, temperature, humidity and status. In addition, the WEB-IO-34 provides power to the attached controller using either an externally-supplied 24 Vac transformer or 24 Vc power supply.

The on-board I/O can be used to monitor pulse contacts from power/demand meters, analog sensors, or transducers, as well as to control energy-consuming devices such as fans, lights or pumps with digital relay outputs. Also included are 8 analog outputs to proportionally control dampers, valves and other devices.

A maximum of one WEB-IO-34 module may be used per WEB-201 controller. However, 2 additional WEB-IO-16 modules can also be used, to provide a total of 32 UIs, 18 relay outputs, and 16 analog output points.

BEFORE INSTALLATION

1. Unpack the WEB-IO-34 Compact Direct Expansion Module.
2. Inspect contents of the package for damaged or missing components.
3. Check the equipment and report any damage to a Honeywell representative at once and return any damaged components for immediate repair or replacement. See RETURNING A DEFECTIVE UNIT section.
4. Read all of these instructions and ensure they are understood.

Included in this Package

Included in this package you should find the following items:

- One WEB-IO-34 module, with grounding wire having a quick-disconnect 0.187 in. (4.75 mm) female connector.
- WEB-IO-34 INSTALLATION INSTRUCTIONS, literature no. 95-7724.
- One 15-position terminal plug and three 12-position terminal plugs, for I/O wiring.
- One 2-position terminal plug, for 24 Vac power.
- Sixteen 499-ohm resistors for 4-20 mA inputs.

Materials and Tools Required

The following tools and supplies are required for installation:

- A suitable power source, as one of the following:
 - UL listed, Class 2, 24 Vac transformer, rated a minimum of 8.5 VA to 20 VA (approximate range of WEB-201 with WEB-IO-34 alone, to fully-expanded unit with 2 additional WEB-IO-16 modules and other option boards). A *dedicated* transformer is required (cannot power additional equipment).
 - 24 Vdc power supply, capable of supplying at least 1 A (24 W).
- DIN rail, type NS35/7.5 (35 mm x 7.5 mm) recommended for mounting with WEB-201 controller. The DIN rail should be sufficient length to accommodate both the WEB-201 controller and WEB-IO-34 module. See Fig. 2.
- Suitable screws and screwdriver for mounting DIN rail, or if DIN rail not used, for mounting bases of WEB-201 controller and WEB-IO-34 module.
- Small flat-blade screwdriver: used for mounting or removing the WEB-IO-34 module from DIN rail, also for screw terminals on I/O connectors and 24 V power connector.



SAFETY INSTRUCTIONS

NOTES REGARDING DEVICE DESCRIPTION

These instructions include guidelines for use and mounting of the device. In case of questions that cannot be answered with these instructions, please consult the product supplier or manufacturer. It is the responsibility of the equipment installer to ensure that all federal, state and local codes are followed.

SAFETY INSTRUCTIONS

- Keep these Installation Instructions for industrial safety and the prevention of accidents.
- The information in these instructions must be read and understood by every person using this device.
- The following items share warnings of a general nature relating to the installation and start-up of the WEB-201 series controller.
- Be sure to heed these warnings to prevent personal injury or equipment damage.

WARNING

- A 24 Vac or 24 Vdc circuit powers the WEB-IO-34 module and attached WEB-201 controller. Disconnect power before installation or servicing to prevent electrical shock or equipment damage.
- Make all connections in accordance with national and local electrical codes. Use copper conductors only.
- To reduce the risk of fire or electrical shock, install in a controlled environment relatively free of contaminants.
- WEB controllers and I/O modules are only intended for use as monitoring and control devices. To prevent data loss or equipment damage, do not use for any other purposes.

Static Discharge Precautions

The following items are cautionary notes that will help prevent equipment damage or loss of data caused by static discharge.

CAUTION

- **Static charges produce voltages high enough to damage electronic components. The microprocessors and associated circuitry within WEB-IO-34 modules are sensitive to static discharge. Follow these precautions when installing, servicing or operating the system:**
- **Work in a static free area.**
- **Discharge any static electricity you may have accumulated. Discharge static electricity by touching a known securely grounded object.**
- **Do not handle the printed circuit board (PCB) without proper protection against static discharge. Use a wrist strap when handling PCBs, with the wrist strap clamp secured to earth ground.**

I/O Module Connection Precautions

CAUTION

- **Avoid “hot” plug-in or removal of any WEB-IO module from the controller (or other accessory module), meaning first remove power from the unit. If the unit switches to battery operation, wait for all LEDs to go out.**
- **Plugging or unplugging a WEB-IO module from a powered WEB controller should not cause damage to either the controller or WEB-IO module hardware. However, note that all WEB-IO modules are initialized upon station startup and if not (continuously) present following a power cycle, will be inoperable.**
- **Do not plug in more than (2) WEB-IO-16 modules into a single WEB-201 controller. Doing so will have unexpected effects on the software, and may overload the power supply.**
- **WEB-IO modules are designed to be directly plugged into the WEB-201 controller or directly attached modules. Do not use a ribbon cable or extend the length of the I/O cable as this will increase radiated signal noise, decreasing analog stability, and may introduce communication problems.**

INSTALLATION AND START-UP OUTLINE

NOTE: If installing the WEB-201 controller and WEB-IO-34 module at the same time, refer to the WEB-201 INSTALLATION INSTRUCTIONS guide literature no. 95-7722 to install the WEB-201 controller. In this case, the WEB-IO-34 module is typically the “approved power source”, used *in place* of a WEB-NPB-PWR module. A maximum of 2 additional WEB-IO-16 modules are supported. See Fig. 2.

The major steps to installing and starting the WEB-IO-34 module are outlined as follows:

1. Physically mount the WEB-IO-34 module with the WEB-201 controller. See MOUNTING section. Make sure that the I/O input connector is properly seated into the I/O connector on the WEB-201 controller (or if used, another WEB-IO-16 module). Refer to the previous I/O Module Connector Precautions section.
2. Make wiring connections for earth ground, 24 Vac power and I/O wiring. See WIRING section.
3. Apply power and perform an initial checkout. See POWER UP AND INITIAL CHECKOUT section.

MOUNTING

The following applies to mounting a WEB-IO-34 module with a WEB-201 controller:

- The units may be mounted in any orientation. It is not necessary to remove the covers before mounting.
- Mounting on a 1.4 in. (35 mm) wide DIN rail is recommended. Both the WEB-201 unit base and the WEB-IO-34 unit base have a molded DIN rail slot and locking clip as does the WEB-IO-16 expansion

module. Mounting a DIN rail ensures accurate alignment of connectors between all modules.

- If DIN rail mounting is impractical, screws in mounting tabs may be used on the WEB-201 controller and then in the WEB-IO-34 module. Mounting tab dimensions are shown in Fig. 1.

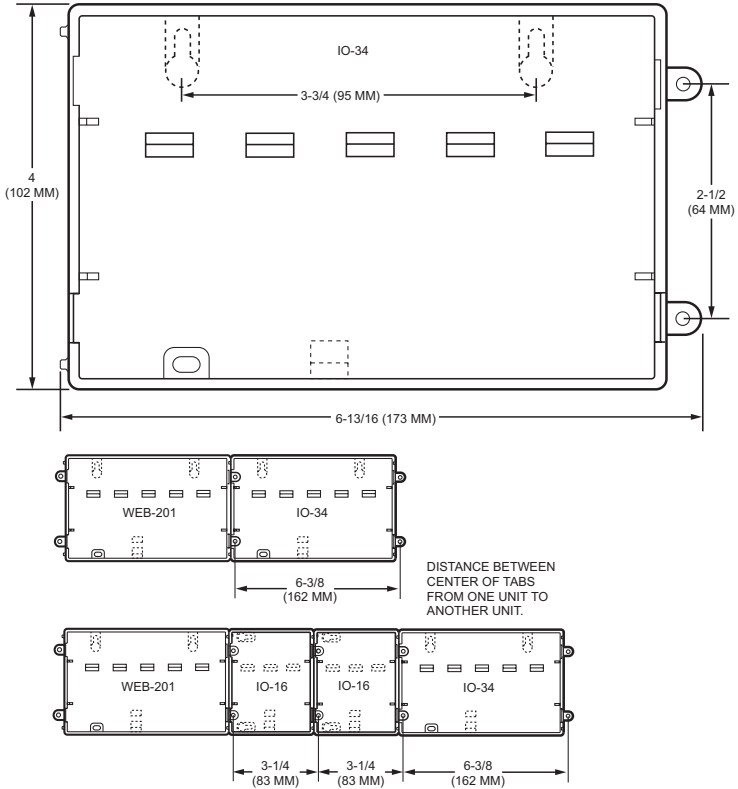

NOTES: ELECTRONIC AND PRINTED VERSIONS OF THIS GUIDE MAY NOT SHOW THE DIMENSIONS TO SCALE.

VERIFY ALL MEASUREMENTS DRILLING.

DIN MOUNTING IS RECOMMENDED OVER TAB MOUNTING. SEE FIGURE 2.

M23283

Fig. 1. Tab mounting dimensions in inches (mm).

Procedure 1 provides step by step mounting instructions for the WEB-IO-34 module on an existing installed DIN rail.

NOTES: If the WEB-201 controller is already in use:

- Back up its configuration to your PC using Niagara AX™ Workbench 3.n.n.n. This is done using a platform connection to the controller, using the backup command in the **Platform Administration** view.

- Turn off the power to the controller and disconnect the power cord. Be sure that all of the LEDs are off. Make sure that the controller is not running off of battery power.
- Remove any other power source: NPB-WPM-US (wall mount) or WEB-NPB-PWR (DIN mount) module. **Do not reconnect a NPB-WPM-US** (wall mount module) after installing and powering the WEB-IO-34 module. The WEB-IO-34 should be the only power source for the WEB-201 controller.

Procedure 1. Din rail mount.

Step 1	Remove the bottom I/O connector plug(s) that cover the plastic DIN locking clip.
Step 2	Position the WEB-IO-34 module on the rail, tilting to hook DIN rail tabs over one edge of the DIN rail. (See Fig. 2)
Step 3	Use a screwdriver to pry down the plastic locking clip, and push down and in on the WEB-IO-34, to force the clip to snap over the edge of the DIN rail.
Step 4	Slide the WEB-IO-34 module along the DIN rail to connect its 20-position plug into WEB-201 controller (or if used, another WEB-IO-16 module). With all modules connected, the WEB-IO-34 module is at one end.
Step 5	To keep this assembly from sliding on the DIN rail, secure the WEB-IO-34 (last module) with clips provided by the DIN rail vendor, or place a screw in one of the mounting tabs in the base of the WEB-IO-34 module.

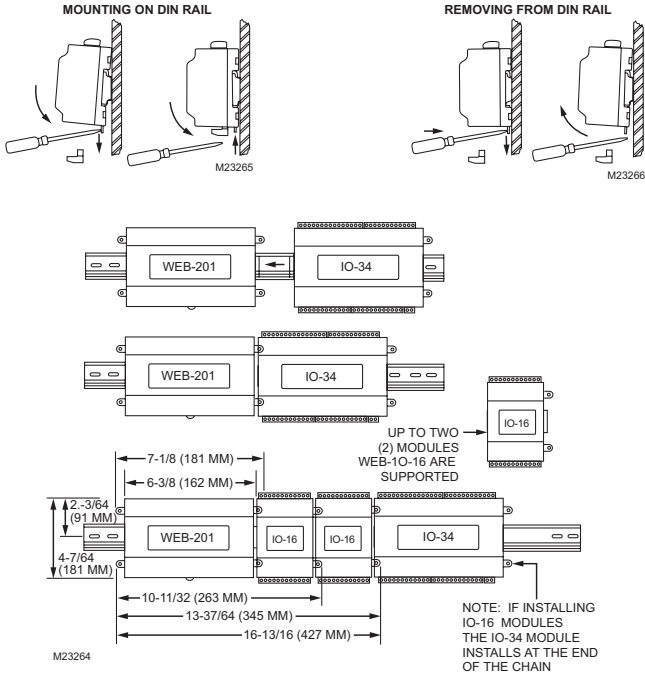

Fig. 2. WEB-IO-34 Module mounting details.

NOTE: To remove WEB-IO-34 module from DIN rail, slide it away from other modules. Insert a screwdriver in the center plastic locking tab and pull downwards, then lift the unit outwards. It may be necessary to remove an I/O connector plug as shown at the top of Fig 2.

BOARD LAYOUT AND TERMINAL LOCATIONS

The WEB-IO-34 module provides 16 universal inputs supporting analog inputs (temperature, resistance, voltage and current) and digital inputs (contact closure, pulse count) and 18 outputs: 10 relay (24 Vac/cd, 0.5 A max.) outputs and 8 analog outputs (0-10 Vdc). Wiring terminal positions are shown in Fig. 3 along with LED locations.

WIRING

See Fig. 3 to locate connectors and other components on the controller.

Make connections to the WEB-IO-34 controller in the following order.

1. Connect the earth ground wire (with spade connector) from the earth ground lug on the WEB-IO-16 module to a nearby earth ground point. See GROUNDING section for details.
2. Prepare power wiring (leave the unit powered off). See Power Wiring section for details.
3. Connect I/O wiring. See Inputs and Outputs sections.
4. Apply power to the unit. See POWER UP AND INITIAL CHECKOUT sections.

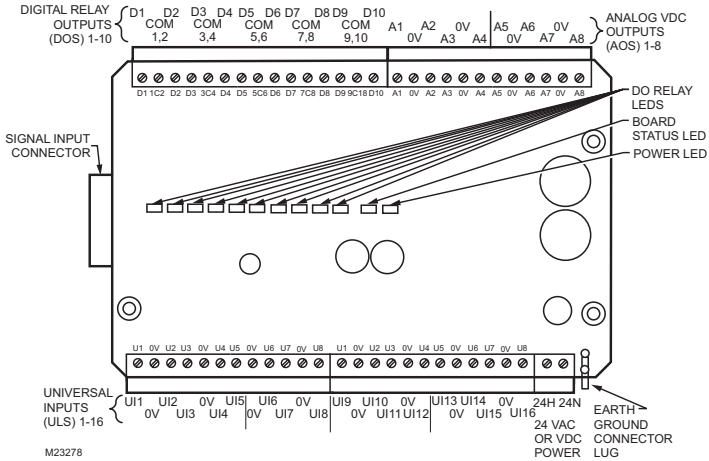

Fig. 3. WEB-IO-34 Wiring terminal locations.

Grounding

An earth ground spade lug 0.187 in. (4.75 mm) is provided on the base of the WEB-IO-34 module (as well as the WEB-201, WEB-IO-16 controller) for connection to earth ground. For maximum protection from electrostatic discharge or other forms of EMI, connect each earth ground using a #16 AWG or larger wire. Keep these wires as short as possible.

See Fig. 4 for the location of the earth grounding wire for WEB-IO-34.

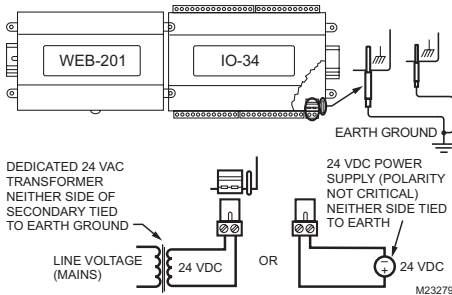

Fig. 4. WEB-IO-34 earth ground connection.

Power Wiring

The WEB-IO-34 module can be powered by wiring to a dedicated Class 2, 24 V transformer, or to a 24 Vdc power source. The WEB-IO-34 provides power to the attached WEB-201 controller and up to two attached WEB-IO-16 modules (if used).

NOTE: If powering from a 24 V transformer, do not power other equipment with it. Otherwise, conducted noise problems may result. Also, do not ground either side of the transformer's 24 V secondary.

Power consumption depends on installed accessories and option cards, and may vary from:

- WEB-201 controller with WEB-IO-34 module alone: approximately 8.5 VA (AC) or 8.5 W (DC)
- WEB-201 with WEB-IO-34, 2 additional WEB-IO-16 modules, plus option boards: up to 20 VA (AC) or 20 W (DC).

As shown in Fig. 4, the WEB-IO-34 module's 2-position power connector is located at the lower corner of the unit. Unplug the connector from the module and make connections to it as shown.

NOTE: Do not apply 24 V power (reinsert connector plug into the WEB-IO-34) until all other wiring is completed, including WEB-IO-34 inputs and outputs. See POWER UP AND INITIAL CHECKOUT section.

Inputs

Each of the 8 universal inputs (UI) can support any one of the following:

- Type-3 10K ohm Thermistor (also see Note in Resistive 0-100k ohms section)
- Resistive 0-100K ohms
- 0-10 Vdc
- 4-20 mA
- Binary Input

Thermistor

The inputs support 10K Thermistor temperature sensors using a ThermistorInputPoint. Input accuracy is in the range of $\pm 1\%$ of span. By default, conversion is for standard Type 3 thermistor sensor, with a sensor range of -10° to 135° F (23.3° to 57.2° C). Using a conversion type of "Tabular Thermistor", a different thermistor response curve can be specified by importing a thermistor curve.xml file. Currently, the Ndio module contains an xml folder with thermistor curves for a Radio Shack sensor model 271-0110 and TE-6300 10K type sensor. Customized thermistor xml files may be edited or exported (for reuse). See the Niagara AX Ndio Guide for more details. Fig. 5 shows the wiring diagram.

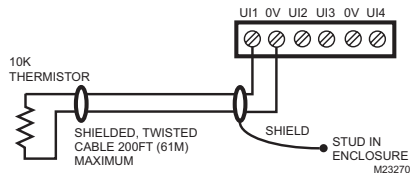

Fig. 5. Thermistor wiring.

Resistive 0-100K ohms

The inputs can read a resistive signal within a range from 0 to 100,000 ohms. Wiring is the same as shown for a Thermistor temperature sensor. See Fig. 5.

Resistive signals require a **ResistiveInputPoint**.

NOTE: UI inputs are optimized to provide the best resolution around the 10K ohm range. For a sensor with a range far from 10K ohms (such as 100-ohm type), resolution will be poor. To use such a sensor, it is recommended a transmitter that produces a Vdc or mA signal be installed. Wire the transmitter to the UI according to the 0-10 Vdc or 4-20 mA instructions.

0-10 Vdc

The inputs support self-powered 0-10 Vdc sensors. Input impedance is greater than 5K ohms. 0-10 volt accuracy is $\pm 2\%$ of span, without user calibration. Fig. 6 shows the wiring diagram. 0-10 Vdc sensors requires a **VoltageInputPoint**.

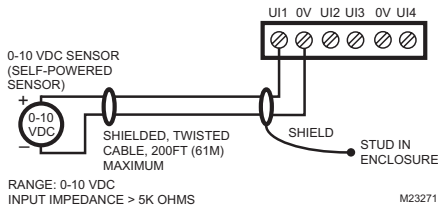

Fig. 6. 0-10 Vdc wiring.

4-20 mA

The inputs support self-powered 4-20 mA sensors. Input accuracy is $\pm 2\%$ of span, without user calibration. Fig. 7 shows the wiring diagram, which requires a 499 ohm resistor wired across the input terminals. 4-20 mA sensors also require the **VoltageInputPoint**.

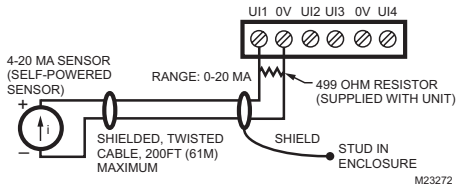

Fig. 7. 4-20 mA wiring.

Binary Input

The universal inputs support both pulse contacts and normal dry (equipment status) contacts.

- Pulse contacts may have a change-of-state (COS) frequency of up to 20 Hz with a 50% duty cycle.

NOTE: Minimum dwell time must be > 25 ms. (Contacts must remain open at least 25 ms and be closed at least 25 ms)

- Standard dry contacts must have a 1 Hz (or less) COS frequency, with minimum dwell time > 500 ms. (Contacts must remain open at least 500 ms and be closed at least 500 ms)

Both types of dry contacts support 3.3 Vdc open circuits or 330 μ A short-circuit current.

Fig. 8 shows the wiring diagram. For a pulse diagram contact use the **CounterInputPoint** in the station database. For other dry contacts, use the **BooleanInputPoint**.

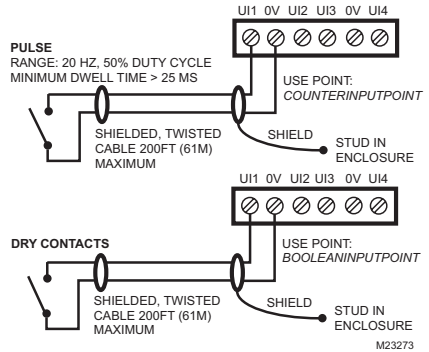

Fig. 8. Binary input wiring.

Outputs

The WEB-IO-34 module has 10 digital relay outputs and 8 0-10 volt analog outputs.

Relay Outputs

Each relay output is rated at 24 Vac or Vdc at 0.5 A. Relay outputs have MOV (metal oxide varistor) suppressors to support inductive type loads such as heavy duty relay coils.

⚠ WARNING

Relays are not rated for AC mains (line level) powered loads (instead, 24 V maximum). Never use the controllers power transformer to power I/O loads. Using controller transformer introduces potentially damaging switching transients into the controller.

Use a **BooleanOutputWritable** in the station for each output. Fig. 9 shows an example wiring diagram.

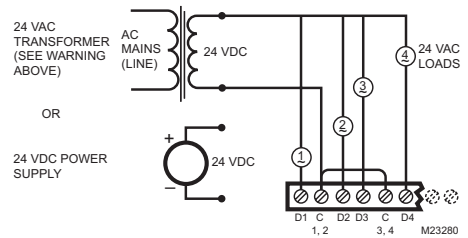

Fig. 9. Relay output wiring diagram.

NOTE: 15-position DO connector plug has 5 common terminals "C" (1 -2, 3 -4, 5 -6, 7 -8, 9 -10), which are isolated from each other. This can be useful when powering loads from different 24 Vac sources.

A yellow LED status indicator for each relay (D1 - D10) is located on the board (Fig. 3), and also visible through the cover. Under normal operation, each digital status LED indicates activity as follows:

- **Off** - relay open/no current flows.
 - **On** - relay closed/load current flows.
- Therefore, an **On** status indicates that the load is powered.

Analog Outputs

Analog Outputs (AO) are referenced by the terminals labeled *An* and 0 V (ground). Each AO can supply a maximum of 4 mA over the entire 0 to 10 Vdc range. The minimum input impedance of a device controlled by an AO must be greater than 2500 ohms. Typical wiring for an AO is shown in Fig. 10.

For each AO, use a **VoltageOutputWritable** in the station database.

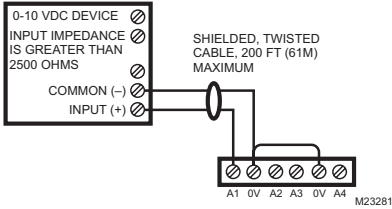

Fig. 10. Analog output wiring diagram.

SOFTWARE DESCRIPTION

In the Niagara station interface to the WEB-201 controller, each I/O module appears as one **NdioBoard** under the station's **NdioNetwork**. If a WEB-201 controller has only one WEB-IO-34 module, the NdioNetwork has a single **NdioBoard** component, where the "Io Port" property of the **NdioBoard** is 1. See Fig. 10, top.

Upon discovery, if the WEB-201 controller has multiple WEB-IO-16 modules, the module closest to the WEB-201 controller is the first **NdioBoard** (property Io Port 1), the next module in the chain is **NdioBoard1** (property Io Port 2), and the third module is **NdioBoard2** (property Io Port 3). See Fig. 11, bottom.

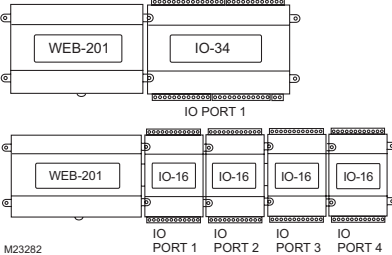

Fig. 11. WEB-201 controller **NdioBoard** (port) assignment.

Once the operating system identifies the Ndio processors, the I/O board status LED on each WEB-IO module turns green. The green status LED means that the controller is able to communicate with the I/O. It does not indicate anything about the status of the Niagara station or its Ndio components.

NOTE: Any time a powered WEB-IO module's status LED is not lit, all outputs are in "failsafe" state (all relay outputs OFF, and all AOs are at a 0-volt level). See Fig. 3 for location of the WEB-IO-16 status LED.

Each type input or output used requires a special Niagara Direct Input/Output (Ndio) point to be added in the station database. These components act as the station interface to the physical I/O points. The Ndio points needed for each input or output type are noted in previous wiring sections in **boldface**.

For Ndio component details, see the Ndio Guide in Niagara AX online Help, or the same document in PDF.

POWER UP AND INITIAL CHECKOUT

1. Plug in the 24 V connector plug to apply power. The WEB-IO-34 board and status LED will initially be Off (Fig. 3), but the Power LED on the WEB-IO-34 should be lit. Allow the controller sufficient time to boot (at least 2 minutes).
2. Upgrade the controller firmware if necessary (if controller has a Niagara build earlier than the Workbench). Using a Workbench, open a platform connection to the controller. Use the **Commissioning Wizard** to do this. For more details, see the JACE® Niagara AX Install and Startup Guide, also available in the Workbench online HELP (doc Jace Startup). Make sure to install the Ndio software module.
3. Verify that the WEB-IO-34 board status LED is now lit to green.
4. Using WorkBench, open the station (if running), or open a platform connection and start the station using **Station Director**.
5. If not already present, add an NdioNetwork component to the station's Drivers Container and use "Manager" views and "Learn Mode" to discover and add Ndio components to the station database. See SOFTWARE DESCRIPTION section. For more details about Ndio components, refer to the Ndio Guide, also available in Workbench online Help (doc Ndio).

RELATED DOCUMENTATION

For more information on configuring and using WEB-201 series controllers, consult the following documents:

- WEB-201 Installation Instructions.
- JACE Niagara AX Install and Startup Guide
- Niagara AX Ndio Guide
- Niagara AX User Guide
- WEB-IO-16 Installation Instructions

REPLACEMENT PARTS

Servicing the WEB-IO-34 modules may call for replacement parts. There are two categories of parts:

- Standard Replacement Parts
- New Replacement Units

Standard Replacement Parts

Standard replacement parts are listed in Table 1 and can be ordered from stock without restriction. Standard replacement parts cannot be returned for credit and should be disposed of in an appropriate manner.

Table 1. Standard replacement parts.

Part Number	Description
10149	Resistor, 499 ohm, 1%, 0.6 w
10600	Connector plug, 15-position screw terminal, 180 deg. (1 used for DOs)
10599	Connector plug, 12-position screw terminal, 180 deg. (3 used: 2 for UIs, 1 for AOs)
10598	Connector plug, 2-position screw terminal, 180 deg. (1 used for 24 V power)
10370	Grounding wire with quick-disconnect 0.187 in. (4.75 mm) female connector

New Replacement Units

To replace a faulty unit, order and install a new WEB-IO-34 accessory module.

NOTE: WEB-201 series products do not have special “field replacement units”, or FRU’s, with separate part numbers.

If the faulty WEB-IO-34 module is still in warranty credit may be received by returning it to Honeywell. Be sure to contact Honeywell for a return authorization (RA) number before shipping an item for return credit. See RETURNING A DEFECTIVE UNIT section for details.

NOTE: Before ordering a new WEB-IO-34 module, it is strongly recommended that normal technical support resource be used to eliminate the possibility of a software issue or mis-configuration problem.

MAINTENANCE

Module Replacement



CAUTION

Before handling circuit boards, discharge any accumulated static by touching the nearby earth grounding point. For details, see Static Discharge Precaution section.

To replace the WEB-IO-34 accessory module in the field, proceed as follows:

Procedure 2. Accessory Module Replacement.

Step 1	Using the appropriate Niagara software tool, back up the controller configuration to your PC.
Step 2	Remove power to the WEB-IO-34 controller. The unit should power down automatically.
Step 3	Record positions of all I/O wiring going to the WEB-IO-34. If necessary, label connectors to avoid mis-connection later (after WEB-IO-34 module is replaced). NOTE: The software that runs on the WEB-201 controller expects the terminal positions to be the same in the replacement WEB-IO-34 module, in order to collect data from or to control the attached devices.
Step 4	If any I/O points have voltage, turn the devices off, or disconnect power to them.
Step 5	Unplug all connectors from the WEB-IO-34 module, including all I/O connectors and earth ground wire.
Step 6	Remove any screws or DIN rail clips securing the WEB-IO-34 module, removing it from its mounting.
Step 7	Mount the replacement WEB-IO-34 module as it was previously, using the same DIN rail location and/or screws.
Step 8	Reconnect the earth ground wire to the grounding lug.
Step 9	Reconnect all I/O connectors to the WEB-IO-34 module.
Step 10	If any of your I/O points have voltage, turn the devices back on, or reconnect power to them.
Step 11	Restore power to the WEB-IO-34 module and perform a checkout using Niagara AX Workbench (see POWER UP AND INITIAL CHECKOUT section).
Step 12	For more details, see the Niagara AX Ndio Guide and JACE Niagara AX Install and Startup Guide.

RETURNING A DEFECTIVE UNIT

NOTES: If the defective unit is under warranty, follow return instructions provided in this section. If the unit is out of warranty, discard the unit.

- Do not return an out-of-warranty WEB-IO-34 module to Honeywell.
- There is no “return for repair-and-return” service available for any of the WEB-201 series products.

For proper credit on an in-warranty unit, ship the defective unit to Honeywell within 30 days.

Prior to returning the unit, contact one of the Honeywell offices to obtain a return authorization (RA) number and other instructions. See last page of document for Honeywell contact information. Please provide:

- Product model
- Serial number
- Number of the defect
- Nature of defect

Automation and Control Solutions

Honeywell International Inc.
1985 Douglas Drive North
Golden Valley, MN 55422
customer.honeywell.com

Honeywell Limited-Honeywell Limitée
35 Dynamic Drive
Scarborough, Ontario M1V 4Z9

